

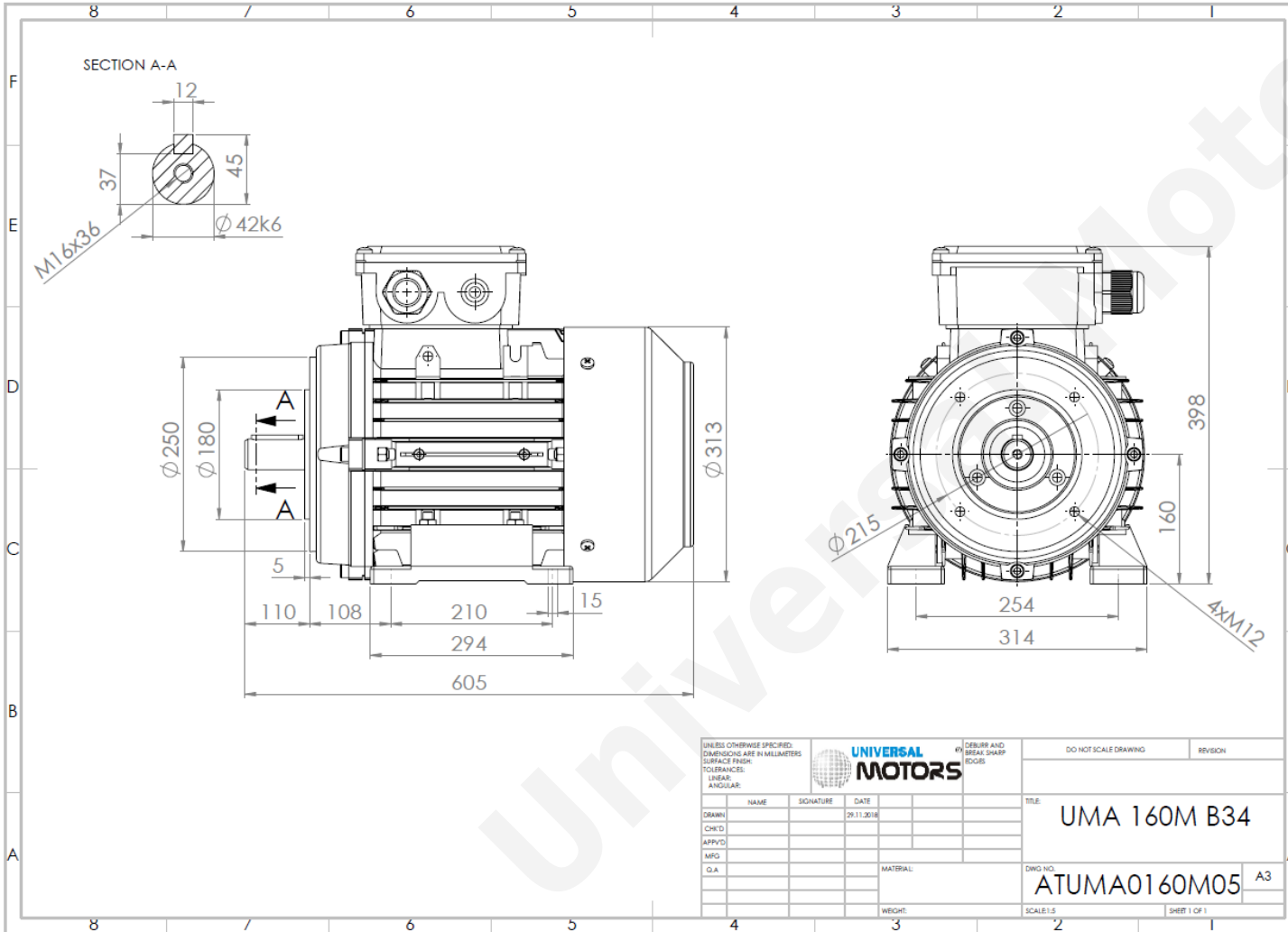

TECHNICAL DATA

Three Phase Electric Motors - Aluminum Frame
 UM2A 160M2-2
 15 kW / 20 Cv
 2950 RPM



Motor type:	UM2A 160M2-2
Output:	15 kW / 20 Cv
Speed (min ⁻¹):	2950 RPM
Frequency:	50 Hz
Voltage:	400 V
Current:	26.6 A
Power factor (Cos Ø):	0.90
Poles:	2
Insulation class:	F
Temperature rise Class:	B
Efficiency 50%:	89.7 %
Efficiency 75%:	90.5 %
Efficiency 100%:	90.3 %
Torque:	49 N.m
Tstarting/Tnominal:	2.6
Istarting/Inominal:	9.4
Tmaximum/Tnominal:	3.4
Noise:	86 Db(A)
Weight:	91 Kg
Brake AC:	AC8
Torque Brake DC:	200 N.m
Bearing DE:	6309 2Z
Bearing NDE:	6309 2Z
Torque Brake AC:	200 N.m
Brake DC:	K8

Regime - S1

Altitude - 1000m

Environment Temperature - 40°C

CONTACTS:

UNIVERSAL MOTORS Tel: +351 252 299 080
 Rua de São Brás,745 Fax: +351 252 299 089
 4480-782 VILA DO CONDE Mail: geral@universalmotors.pt

* References applied only in the UK